

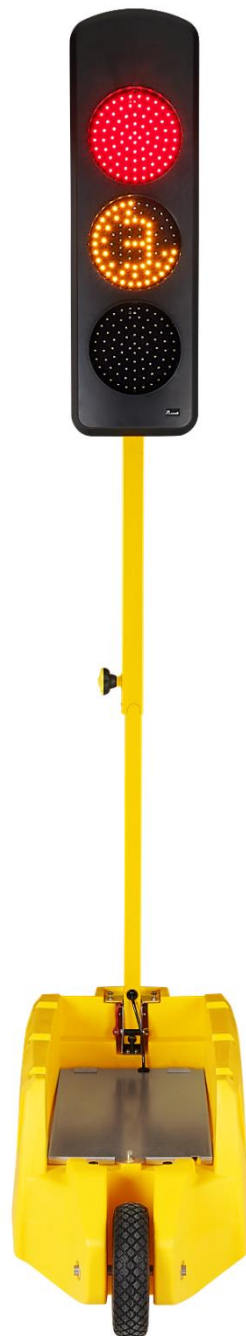

# MILLENIUM / SMART MILLENIUM

## USER MANUAL



**CONTENTS**

<b>1. PREAMBLE.....</b>	<b>3</b>
<b>2. OVERVIEW.....</b>	<b>4</b>
<b>3. PREPARATION FOR DEPLOYMENT .....</b>	<b>6</b>
<b>4. MOVING THE LIGHT .....</b>	<b>7</b>
<b>5. INITIAL ACTIVATION OF LIGHTS .....</b>	<b>7</b>
<b>6. PAIRING .....</b>	<b>8</b>
A. Pairing Procedure .....	9
B. Procedure for Adding a PTL to an Existing System:.....	10
C. Procedure for Removing a PTL from an Existing System: .....	10
<b>7. PROGRAMMING THE PTLS .....</b>	<b>10</b>
A. Standard Mode: .....	11
B. Standard Mode + Worksite Exit .....	12
C. Manual Alternating Mode: .....	13
D. Flashing Yellow Mode:.....	13
E. Manual Mode: .....	14
F. Vehicule actuated Mode: .....	15
G. Green on Request Mode:.....	16
H. Plant crossing Function:.....	17
<b>8. CYCLE IN PROGRESS.....</b>	<b>17</b>
<b>9. PARAMETERS MENU .....</b>	<b>18</b>
A. Language: .....	18
B. Remote Control Settings:.....	18
C. PTL Settings:.....	18
D. Information: .....	18
E. Maintenance:.....	18
F. Reset:.....	18
<b>10. SMART MILLENIUM MENU .....</b>	<b>19</b>
<b>11. PTL SHUTDOWN / STANDBY .....</b>	<b>19</b>
<b>12. REMOTE CONTROL.....</b>	<b>20</b>
A. Activation.....	20
B. Standby:.....	20
C. Remote Control SCREEN:.....	20
D. Switch Off Remote Control: .....	20
E. Audible Alarms:.....	20
F. Power Supply:.....	21
G. Adding a Remote Control to a PTL System:.....	21
H. System Reset:.....	21
<b>13. RADIO .....</b>	<b>21</b>
<b>14. RADAR.....</b>	<b>22</b>
<b>15. AVAILABLE OPTIONS .....</b>	<b>22</b>
A. FLASHING BEACON:.....	22
B. Anti-Theft Bar:.....	22
C. External Countdown Timer: .....	23
D. Anti-Theft Cage:.....	23
<b>16. BATTERY .....</b>	<b>23</b>
<b>17. TRANSPORTATION .....</b>	<b>24</b>
<b>18. CLEANING AND MAINTENANCE.....</b>	<b>24</b>
<b>19. STANDARDS / SAFETY .....</b>	<b>24</b>
<b>20. CONTACT TECHNICAL SUPPORT .....</b>	<b>24</b>

**1. PREAMBLE**

**A. PRECAUTIONS**

Before handling the product or its accessories, the use of the PPE mentioned below is mandatory:



Before using the device, please read this operating manual fully and keep it for future use.

**B. MAKING THE LIGHTS OPERATIONAL:**

Millenium and Smart Millenium traffic lights are all IDENTICAL and INDEPENDENT; there are no master or slave lights.

Power up each light by connecting them to a 12 V battery or two 6 V batteries in series observing the correct polarity or on 230 V (contact your dealer). To switch on the remote control, press one of its buttons.

The lights are switched on, paired and programmed from the remote control.

**C. BATTERY COMPATIBILITY AND BATTERY LIFE:**



*\* Varies according the cycle used, the ambient light, humidity, temperature and the programming mode used. As measurement technology and instruments are constantly evolving, this information is provided for general reference only.*

If the battery level is low, alerts are reported to the remote control allowing the user to replace it before the lights go out (Battery < 24 hrs / Battery < 12 hrs / Battery 1 hr).

When there is less than 24 hours' battery life, the traffic lights automatically switch to STANDARD mode.

If the battery life is less than or equal to 1 hour, the traffic lights switch to autonomy mode, equating to the lights going out, the programming is then retained for 20 minutes, allowing the lights to quickly be returned to operational status after the battery is changed. Beyond this 20-minute period, the pairing is retained, and the lights need to be programmed.



**AFTER SWITCHING TO AUTONOMY MODE, THE PROGRAMMING OF THE PTLs IS PRESERVED FOR 20 MINUTES**

## 2. OVERVIEW

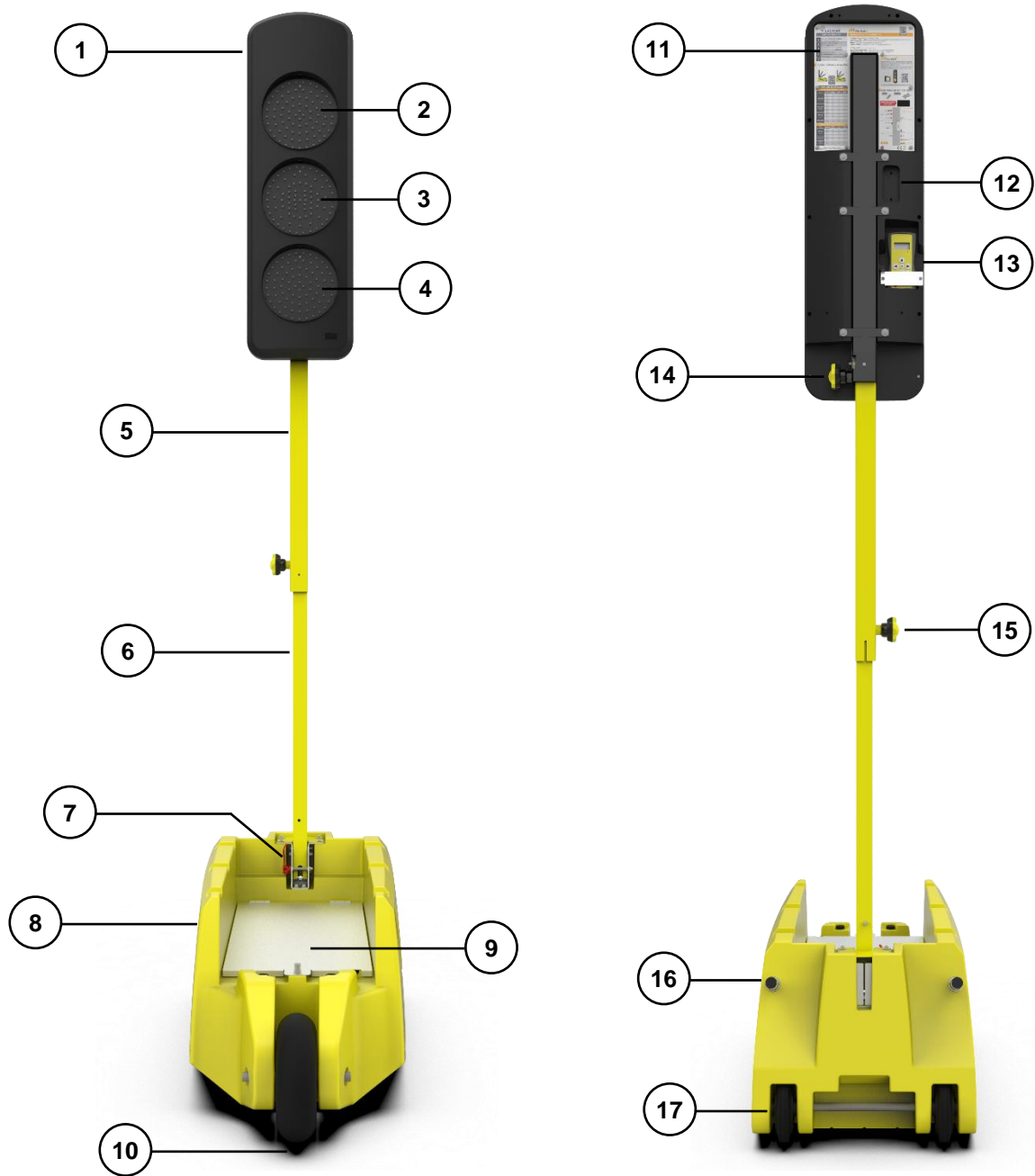

1	LIGHT-HEAD	11	ACCESS PANEL
2	RED LENS	12	FLASHING BEACON SLOT (OPTIONAL)
3	YELLOW LENS / INTERNAL COUNTDOWN TIMER	13	STORAGE SPACE FOR REMOTE CONTROL NO. 1
4	GREEN LENS	14	UPPER EXTENSION LOCKING HANDLE
5	UPPER EXTENSION	15	LOWER EXTENSION LOCKING HANDLE
6	LOWER EXTENSION	16	RETRACTABLE LIFTING ARMS
7	TIGHTENING LEVER	17	PUNCTURE-PROOF REAR WHEELS
8	CHASSIS		
9	BATTERY COVER		
10	PUNCTURE-PROOF FRONT WHEEL		

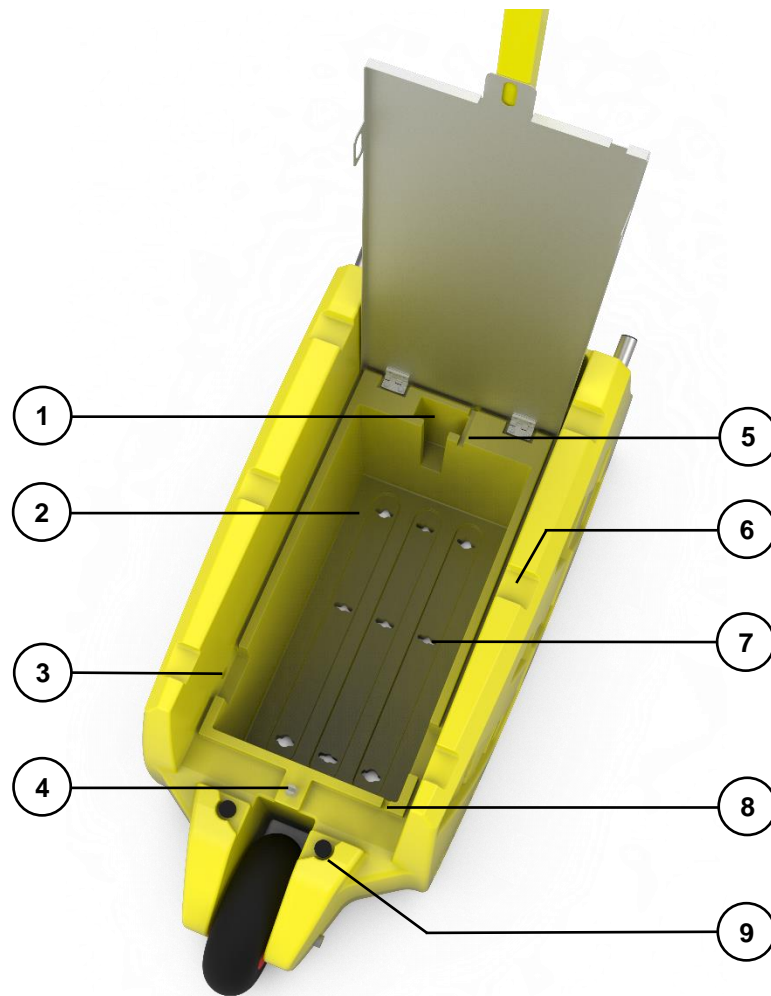

1	STORAGE SPACE FOR REMOTE CONTROL NO. 2
2	BATTERY STRAP PASS-THROUGH / GROUND ANCHORING PASS-THROUGH FOR LIGHT
3	ANTI-THEFT BAR PASS-THROUGH (BAR OPTIONAL)
4	PADLOCK PASS-THROUGH (PADLOCK OPTIONAL)
5	POWER CABLE PASS-THROUGH
6	TRAFFIC LIGHT STACKING PASS-THROUGH
7	GROUND ANCHORING PASS-THROUGH FOR LIGHT
8	230 V POWER CABLE PASS-THROUGH FOR BATTERY CHARGING
9	LIGHT-HEAD GUARD

### 3. PREPARATION FOR DEPLOYMENT

#### A. UNFOLDING THE LIGHT-HEAD:



#### B. FOLDING THE LIGHT-HEAD:

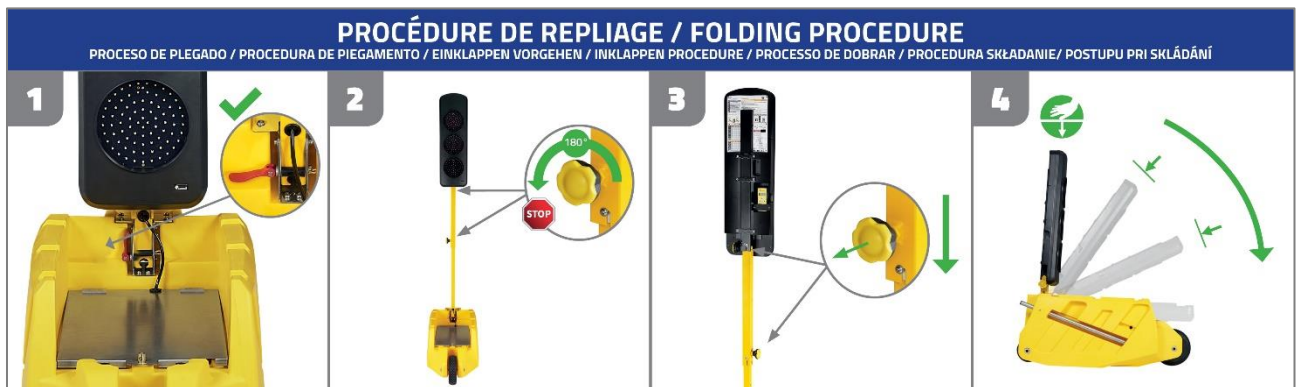

#### C. DEPLOYMENT OF TELESCOPIC EXTENSIONS:

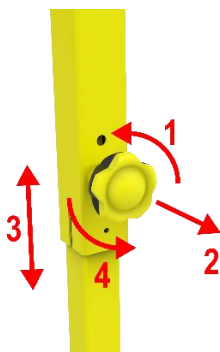

- 1) Loosen the handle half a turn
- 2) Pull to release the locking bolt
- 3) Fold or unfold the extension
- 4) Tighten the handle

**Perform this step on both handles**

#### D. LOCKING/UNLOCKING THE HEAD FOLDING SYSTEM:

Once the extensions have been deployed, lock the tightening lever to ensure optimum stability for the light-head and extensions.

*Note: before folding the light-head over the box, ensure that the tightening lever is in the unlocked position.*

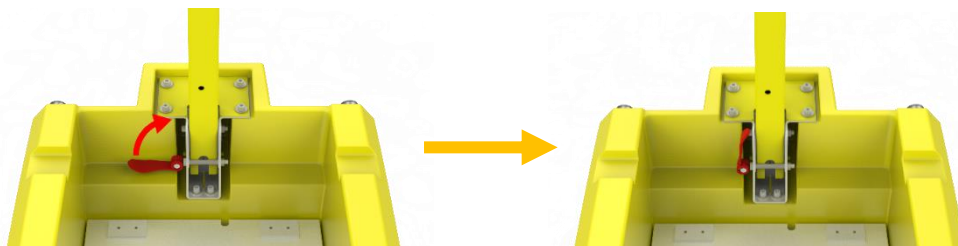

## 4. MOVING THE LIGHT



**Wheelbarrow Mode**



**Trolley Mode**

## 5. INITIAL ACTIVATION OF LIGHTS

The activation procedure allows users to select a country and the language for using Millenium traffic lights.

**QUICK START**

<div style="text-align: center; border: 1px solid #ccc; padding: 5px; background-color: #e0e0e0;">                 QUICK START  <small>FR</small> </div> <div style="text-align: center; border: 1px solid #ccc; padding: 2px; margin-top: 5px;">OK</div>	Select the QUICK START menu from the remote control.
<div style="text-align: center; border: 1px solid #ccc; padding: 5px; background-color: #e0e0e0;">                 SELECT COUNTRY                  FRANCE  <small>FR</small> </div> <div style="text-align: center; border: 1px solid #ccc; padding: 2px; margin-top: 5px;">OK</div>	As the choice of country affects the programming mode of your traffic lights, please ensure you comply with the country where it is used.
<div style="text-align: center; border: 1px solid #ccc; padding: 5px; background-color: #e0e0e0;">                 SELECT LANGUAGE                  FRENCH  <small>FR</small> </div> <div style="text-align: center; border: 1px solid #ccc; padding: 2px; margin-top: 5px;">OK</div>	
<div style="text-align: center; border: 1px solid #ccc; padding: 5px; background-color: #e0e0e0;">                 FINISHED  <small>FR</small> </div>	Position the remote control opposite the infrared signal window located on the back of the light-head.

As activation is stored in the remote control's memory, this step is only required for first use or after a system reset.

**DUE TO SPECIFIC LOCAL REGULATORY REQUIREMENTS, THE SELECTED COUNTRY MUST BE IDENTICAL TO THE COUNTRY WHERE THE PTLs ARE USED.**

## 6. PAIRING

The lights and the remote control are equipped with radios that enable them to communicate to provide enhanced worksite safety. The radio, which is embedded in the remote control, allows it to communicate remotely with the lights deployed, monitor them and receive remote alerts.

The pairing phase makes it possible to group individual lights and the remote control together into a unit called a “system”. A system can contain a maximum of 4 lights and 3 remote controls.

Lights are paired using infrared, the infrared signal window is located on the back of each light-head. The remote control should be positioned a few centimetres away and opposite the infrared signal window.



During pairing, the ID of each light is indicated on the central lens for simplified deployment:

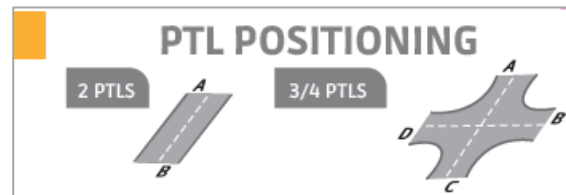
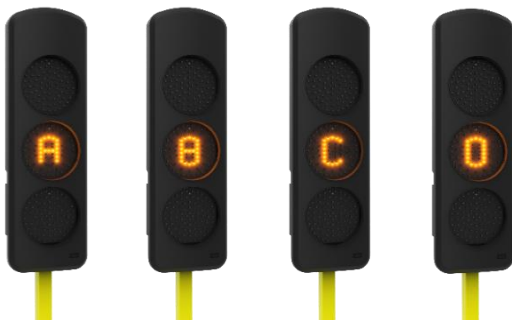

**ENSURE THAT THE LIGHTS TO BE PAIRED ARE POWERED BEFORE BEGINNING THE PAIRING PHASE.**



**IF THE REMOTE CONTROL GOES INTO STANDBY MODE BEFORE PAIRING IS COMPLETE, THE PAIRING IS LOST. ENSURE THE REMOTE CONTROL IS KEPT ACTIVE DURING THE PROCESS BY PRESSING THE BUTTONS ON THE LEFT OR RIGHT. THE STANDBY TIME (1 MIN BY DEFAULT) CAN BE CHANGED FROM THE PARAMETERS MENU, REMOTE CONTROL SETTINGS.**



## A. PAIRING PROCEDURE

PAIRING 2 PTLs	
	Select the PAIRING menu from the remote control.
	Position the remote control opposite the infrared signal window located on the back of the light-head.
	Position the remote control opposite the infrared signal window located on the back of the light-head.
	Select OK to complete pairing.

PAIRING 3/4 PTLs	
	Position the remote control opposite the infrared signal window located on the back of the light-head.
	Position the remote control opposite the infrared signal window located on the back of the light-head.
	Position the remote control opposite the infrared signal window located on the back of the light-head.
	Available choices: FINISH OR NEXT PTL <i>Next PTL: when there are 4 PTL to pair.</i>



**ENSURE THAT THE PTL TO BE PAIRED ARE POWERED BEFORE BEGINNING THE PAIRING PHASE.**



**WHEN THE PTL ARE SWITCHED OFF BY DISCONNECTING THE BATTERIES, THE PAIRING IS SAVED BY THE LIGHTS SYSTEM. THERE IS NO NEED TO REPEAT THIS STEP ON THE NEXT TIME DEPLOYMENT IF THE SYSTEM COMPRISES THE SAME LIGHTS AND THE SAME REMOTE CONTROL.**



**IF THE REMOTE CONTROL GOES INTO STANDBY MODE BEFORE PAIRING IS FINISHED, THE PAIRING IS LOST. ENSURE THE REMOTE CONTROL IS KEPT ACTIVE DURING THE PROCESS BY PRESSING THE BUTTONS ON THE LEFT OR RIGHT. THE STANDBY TIME (1 MIN BY DEFAULT) CAN BE CHANGED FROM THE PARAMETERS MENU, REMOTE CONTROL SETTINGS.**

**B. PROCEDURE FOR ADDING A PTL TO AN EXISTING SYSTEM:**

Adding a light to an existing system makes it possible to switch from a 2-light system to a 3- or 4-light system. The ADD LIGHT function is available from the PARAMETERS menu.

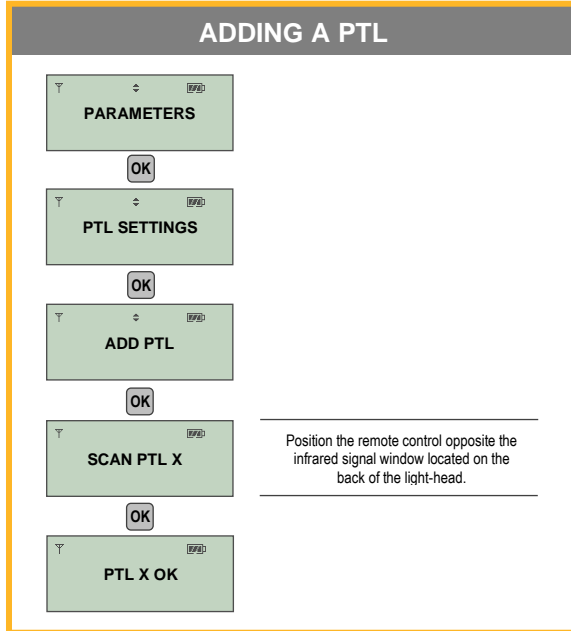

 **ADDING A PTL WHEN THERE IS A CYCLE IN PROGRESS INTERRUPTS THE CYCLE AND CAUSES THE PTLs TO CHANGE TO RED.**

**C. PROCEDURE FOR REMOVING A PTL FROM AN EXISTING SYSTEM:**

To remove or replace a PTL, a new pairing is required. Refer to the PAIRING chapter for more information.

**7. PROGRAMMING THE PTLs**

Once the PTLs have been PAIRED, the PROGRAMMING menu appears. This menu gives you a choice of 7 programmable modes for your PTLs:

The following modes are available on MILLENIUM :

- STANDARD MODE
- STANDARD + WORKSITE EXIT MODE (3 paired PTLs minimum)
- MANUAL ALTERNATING MODE (2 paired PTLs maximum)
- FLASHING YELLOW MODE
- MANUAL MODE

SMART MILLENIUM – Traffic Regulation traffic feature 2 additional modes:

- VEHICULE ACTUATED MODE
- GREEN ON REQUEST

**A. STANDARD MODE:**

Classic mode allows you to set up 2, 3 or 4 PTLs.

**2 PTL SYSTEM**

<div style="border: 1px solid #ccc; padding: 5px; margin-bottom: 5px;"> <span style="float: left;">⌵</span> <span style="float: right;">⌵</span> <p style="text-align: center;"><b>NR. VEHIC / DAY LESS THAN 2,000</b></p> <p style="text-align: center;">OK</p> </div> <div style="border: 1px solid #ccc; padding: 5px; margin-bottom: 5px;"> <span style="float: left;">⌵</span> <span style="float: right;">⌵</span> <p style="text-align: center;"><b>SELECT DISTANCE 100m</b></p> <p style="text-align: center;">OK</p> </div> <div style="border: 1px solid #ccc; padding: 5px;"> <span style="float: left;">⌵</span> <span style="float: right;">⌵</span> <p style="text-align: center;"><b>PROGRAMME MODE FINISHED</b></p> </div>	<hr/> <p style="font-size: small;">Available choices: &lt; 2,000 / 2 to 5,000 / 5 to 8,000 / 8 to 11,000</p> <hr/> <p style="font-size: small;">Available choices: 20 m to 2000 m</p> <hr/>
--	---

**3 OR 4 PTL SYSTEM**

<div style="border: 1px solid #ccc; padding: 5px; margin-bottom: 5px;"> <span style="float: left;">⌵</span> <span style="float: right;">⌵</span> <p style="text-align: center;"><b>JUNCTION TYPE CROSSED</b></p> <p style="text-align: center;">OK</p> </div> <div style="border: 1px solid #ccc; padding: 5px; margin-bottom: 5px;"> <span style="float: left;">⌵</span> <span style="float: right;">⌵</span> <p style="text-align: center;"><b>NR. VEHIC / DAY LESS THAN 2,000</b></p> <p style="text-align: center;">OK</p> </div> <div style="border: 1px solid #ccc; padding: 5px; margin-bottom: 5px;"> <span style="float: left;">⌵</span> <span style="float: right;">⌵</span> <p style="text-align: center;"><b>SELECT DISTANCE 100m</b></p> <p style="text-align: center;">OK</p> </div> <div style="border: 1px solid #ccc; padding: 5px;"> <span style="float: left;">⌵</span> <span style="float: right;">⌵</span> <p style="text-align: center;"><b>PROGRAMME MODE FINISHED</b></p> </div>	<hr/> <p style="font-size: small;">Available choices: Crossed / Rotating</p> <hr/> <p style="font-size: small;">Available choices: &lt; 2,000 / 2 to 5,000 / 5 to 8,000 / 8 to 11,000</p> <hr/> <p style="font-size: small;">Available choices: 20 m to 2000 m</p> <hr/>
--	--



**CYCLES BEGIN AFTER ALL RED ALLOWING THE CENTRAL AREA TO BE FULLY CLEARED.**

## B. STANDARD MODE + WORKSITE EXIT

This mode is intended for use on worksites where the work area is equipped with a set of PTLs to allow vehicles to safely exit the work area. On an All Red request (see All Red overview below) from the remote control, the PTLs change to yellow then red, and the worksite PTL change to green. Due to the presence of a minimum of 1 PTL on the worksite, this mode is only available when 3 or 4 PTLs are paired.

**2 TRAFFIC PTLs**

<div style="border: 1px solid #ccc; padding: 5px; background-color: #e0f0e0; text-align: center;">                 NR. PTL TRAFFIC: 2             </div> <div style="text-align: center; margin-top: 5px;">OK</div>	
<div style="border: 1px solid #ccc; padding: 5px; background-color: #e0f0e0; text-align: center;">                 PTL SYNCHRONISED             </div> <div style="text-align: center; margin-top: 5px;">OK</div>	Available choices: Synchronised or Crossed
<div style="border: 1px solid #ccc; padding: 5px; background-color: #e0f0e0; text-align: center;">                 WORKSITE EXITS: 1 PTL             </div> <div style="text-align: center; margin-top: 5px;">OK</div>	Available choices: Nbr of site exits: 1 or 2 <i>Varies based on the number of PTLs paired</i>
<div style="border: 1px solid #ccc; padding: 5px; background-color: #e0f0e0; text-align: center;">                 WORKSITE PTL: PTL B             </div> <div style="text-align: center; margin-top: 5px;">OK</div>	Available choices: Worksite light: Light B or B & D <i>Varies based on the number of PTLs paired</i>
<div style="border: 1px solid #ccc; padding: 5px; background-color: #e0f0e0; text-align: center;">                 PLANT CROSSING MANUAL ACTIV.             </div> <div style="text-align: center; margin-top: 5px;">OK</div>	Available choices: Manual or automatic activation <i>Automatic: only available on Smart Millenium</i>
<div style="border: 1px solid #ccc; padding: 5px; background-color: #e0f0e0; text-align: center;">                 PLANT CROSSING MANUAL DEACT.             </div> <div style="text-align: center; margin-top: 5px;">OK</div>	Available choices: Manual or Automatic deactivation <i>Automatic deactivation timing : MILLENIUM : plant crossing ending after ALL RED timing SMART MILLENIUM : plant crossing ending after 8s of non-detection or after 30 seconds</i>
<div style="border: 1px solid #ccc; padding: 5px; background-color: #e0f0e0; text-align: center;">                 PROGRAMME MODE FINISHED             </div>	

**3 TRAFFIC PTLs**

<div style="border: 1px solid #ccc; padding: 5px; background-color: #e0f0e0; text-align: center;">                 NR. PTL TRAFFIC: 3             </div> <div style="text-align: center; margin-top: 5px;">OK</div>	
<div style="border: 1px solid #ccc; padding: 5px; background-color: #e0f0e0; text-align: center;">                 JUNCTION TYPE CROSSED             </div> <div style="text-align: center; margin-top: 5px;">OK</div>	Available choices: Crossed ou Rotating
<div style="border: 1px solid #ccc; padding: 5px; background-color: #e0f0e0; text-align: center;">                 NR. VEHIC / DAY LESS THAN 2,000             </div> <div style="text-align: center; margin-top: 5px;">OK</div>	Available choices: < 2,000 / 2 to 5,000 / 5 to 8,000 / 8 to 11,000 / 11 to 14,000
<div style="border: 1px solid #ccc; padding: 5px; background-color: #e0f0e0; text-align: center;">                 SELECT DISTANCE 100m             </div> <div style="text-align: center; margin-top: 5px;">OK</div>	Available choices: 20 m to 2000 m
<div style="border: 1px solid #ccc; padding: 5px; background-color: #e0f0e0; text-align: center;">                 WORKSITE EXITS: 1 PTL             </div> <div style="text-align: center; margin-top: 5px;">OK</div>	Available choices: Nbr of site exits: 1 or 2 <i>Varies based on the number of PTLs paired</i>
<div style="border: 1px solid #ccc; padding: 5px; background-color: #e0f0e0; text-align: center;">                 WORKSITE PTL PTL B             </div> <div style="text-align: center; margin-top: 5px;">OK</div>	Available choices: Worksite light: Light B or B & D <i>Varies based on the number of PTLs paired</i>
<div style="border: 1px solid #ccc; padding: 5px; background-color: #e0f0e0; text-align: center;">                 PLANT CROSSING MANUAL ACTIV.             </div> <div style="text-align: center; margin-top: 5px;">OK</div>	Available choices: Manual or Automatic deactivation <i>Automatic: only available on Smart Millenium</i>
<div style="border: 1px solid #ccc; padding: 5px; background-color: #e0f0e0; text-align: center;">                 PLANT CROSSING MANUAL DEACT.             </div> <div style="text-align: center; margin-top: 5px;">OK</div>	Available choices: Manual or Automatic deactivation <i>Automatic deactivation timing : MILLENIUM : plant crossing ending after ALL RED timing SMART MILLENIUM : plant crossing ending after 8s of non-detection on or after 30 seconds</i>
<div style="border: 1px solid #ccc; padding: 5px; background-color: #e0f0e0; text-align: center;">                 PROGRAMME MODE FINISHED             </div>	

**MODE AVAILABLE IF ALL PAIRED PTLs ARE LOCATED AT A MAXIMUM DISTANCE OF 800 M.**

**POSSIBILITY TO ACTIVATE PLANT CROSSING AUTOMATICALLY VIA THE RADAR EVEN IF ALL PTLs ARE NOT FITTED WITH IT. MAKE SURE THAT PTLs WITH RADARS ARE POSITIONED ON THE WORKSITE EXIT ROAD(S). THE ID FOR WORKSITE EXIT PTLs MUST BE B OR D.**

**PLANT CROSSING CAN BE MANUALLY OR AUTOMATICALLY DEACTIVATED. AUTOMATIC DEACTIVATION TIMING DEPENDS IF PTL ON WORKSITE EXIT IS EQUIPPED WITH REGULATION RADAR OR NOT.**

- ▶ **MILLENIUM (NO RADAR) : PLANT CROSSING DURATION = ALL RED TIMING**
- ▶ **SMART MILLENIUM (WITH RADAR) : PLANT CROSSING ENDING AFTER 8SEC OF NON DETECTION OR AFTER 30SEC**

**CYCLES BEGIN AFTER ALL RED ALLOWING THE CENTRAL AREA TO BE FULLY CLEARED.**

**C. MANUAL ALTERNATING MODE:**

Mode suitable for worksites requiring dynamic alternating lanes. The user manually operates the alternating system by giving the green light or red light from the remote control. As PTLs are interconnected by radio, giving the green light to traffic from one direction means that the PTL for the other direction will automatically switch to red. An All Red phase can also be simulated from the remote control.

Mode reserved for systems comprising 2 paired PTLs and worksites with perfect visibility of all traffic. To further enhance safety when using this mode, LACROIX City recommends using flashing beacons, which are sold separately.

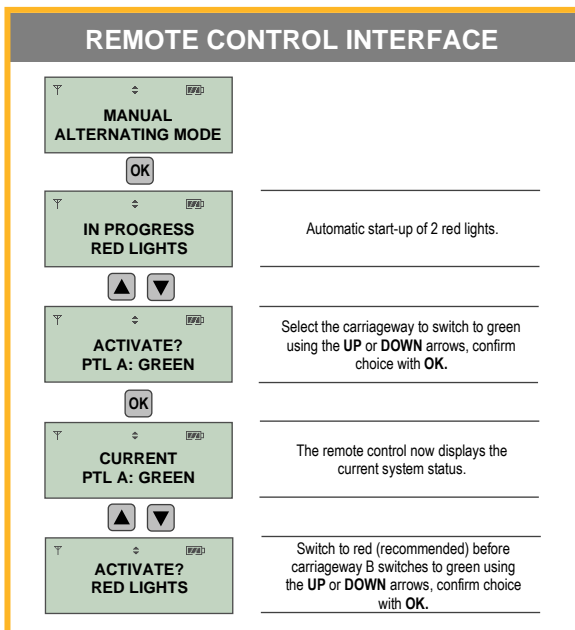

 **CYCLES BEGIN IMMEDIATELY FOLLOWING MODE SELECTION.**

**D. FLASHING YELLOW MODE:**

This mode activates the flashing yellow on the central lens, mode used when the traffic no longer requires an alternating traffic flow system to be implemented. The mode is also automatically activated on all currently operating system lights in the following situations:

- Battery life < 12 hrs
- Battery disconnected from the PTL during use
- Radio fault (if modes Standard + Worksite Exit, Automatic Regulation, Green on Request are active)
- Red lens fault (> 50% of the lens is faulty)
- PTL moved/fallen

Mode does not require any programming from the user.

 **CYCLES BEGIN IMMEDIATELY FOLLOWING MODE SELECTION.**

**E. MANUAL MODE:**

This mode allows the cycle duration to be manually adjusted.

**REMOTE CONTROL INTERFACE**

<div style="border: 1px solid #ccc; padding: 5px; background-color: #e0f0e0;"> <span style="float: left;">T</span> <span style="float: right;">EPP</span> <p style="text-align: center;">MANUAL MODE</p> <p style="text-align: center; margin-top: 5px;">OK</p> </div>	
<div style="border: 1px solid #ccc; padding: 5px; background-color: #e0f0e0;"> <span style="float: left;">T</span> <span style="float: right;">EPP</span> <p style="text-align: center;">CENTRAL YELLOW 5 SECS</p> <p style="text-align: center; margin-top: 5px;">OK</p> </div>	<p>Adjusts the length of the central yellow (5 secs = regulatory duration) using the UP and DOWN keys.</p>
<div style="border: 1px solid #ccc; padding: 5px; background-color: #e0f0e0;"> <span style="float: left;">T</span> <span style="float: right;">EPP</span> <p style="text-align: center;">SELECT DISTANCE 100m</p> <p style="text-align: center; margin-top: 5px;">OK</p> </div>	<p>Distance adjustable from 20 to 2,000 m using the UP and DOWN keys.</p>
<div style="border: 1px solid #ccc; padding: 5px; background-color: #e0f0e0;"> <span style="float: left;">T</span> <span style="float: right;">EPP</span> <p style="text-align: center;">GREEN DURATION 20 SECS</p> <p style="text-align: center; margin-top: 5px;">OK</p> </div>	<p>Green duration adjustable from 5 to 120 seconds <i>Pressing and holding the UP and DOWN keys allows the user to increase or decrease the time in 10-second increments.</i></p>
<div style="border: 1px solid #ccc; padding: 5px; background-color: #e0f0e0;"> <span style="float: left;">T</span> <span style="float: right;">EPP</span> <p style="text-align: center;">PROGRAMME MODE FINISHED</p> </div>	



**MODE RESERVED FOR EXPERIENCED USERS.**



**CYCLES BEGIN AFTER ALL RED ALLOWING THE CENTRAL AREA TO BE FULLY CLEARED.**



**WHEN THE COUNTRIES BELGIUM, GERMANY, POLAND, CZECH REPUBLIC OR OTHER ARE SELECTED FROM THE ACTIVATION MENU, THE DURATION FOR THE CENTRAL YELLOW IS REPLACED BY THE DURATION OF THE CENTRAL YELLOW + RED.**

**F. VEHICLE ACTUATED MODE:**



**Mode available on Smart Millenium – Traffic Regulation fitted with regulation radars.**

Equipped with regulation radars built into each light-head, Smart Millenium - traffic regulation enable the optimised, dynamic and automatic regulation of vehicle flows.

Once the cycles have begun, the regulation radars analyse the traffic and automatically adjust their cycles to the traffic. The most-used road or roads will have a longer time on green than less-used roads.

By adjusting their cycles to how busy the location is where they are installed, Smart Millenium offer motorists reduced waiting time. Site workers will also benefit from a better regulated and less stressful worksite.

**REMOTE CONTROL INTERFACE**

<div style="border: 1px solid #ccc; padding: 5px; background-color: #e0e0e0;"> <p style="text-align: center; margin: 0;">VEHICLE ACTUATED MODE</p> <p style="text-align: center; margin: 0;">OK</p> </div>	
<div style="border: 1px solid #ccc; padding: 5px; background-color: #e0e0e0;"> <p style="text-align: center; margin: 0;">JUNCTION TYPE CROSSED</p> <p style="text-align: center; margin: 0;">OK</p> </div>	<p style="font-size: small;">Available choices: Crossed or Rotating</p>
<div style="border: 1px solid #ccc; padding: 5px; background-color: #e0e0e0;"> <p style="text-align: center; margin: 0;">NR. VEHIC / DAY LESS THAN 2,000</p> <p style="text-align: center; margin: 0;">OK</p> </div>	<p style="font-size: small;">Available choices: &lt; 2,000 / 2 to 5,000 / 5 to 8,000 / 8 to 11,000 / 11 to 14,000</p>
<div style="border: 1px solid #ccc; padding: 5px; background-color: #e0e0e0;"> <p style="text-align: center; margin: 0;">SELECT DISTANCE 100m</p> <p style="text-align: center; margin: 0;">OK</p> </div>	<p style="font-size: small;">Available choices: 20 to 2,000 m</p> <p style="font-size: x-small;">Pressing and holding the UP and DOWN keys allows the user to quickly increase or decrease the distance in increments.</p>
<div style="border: 1px solid #ccc; padding: 5px; background-color: #e0e0e0;"> <p style="text-align: center; margin: 0;">PROGRAMME MODE FINISHED</p> </div>	

**VEHICLE ACTUATED MODE ONLY AVAILABLE IF ALL PAIRED PTLs ARE EQUIPPED WITH REGULATION RADARS AND LOCATED AT A MAXIMUM DISTANCE OF 800 M.**

**CYCLES BEGIN AFTER ALL RED ALLOWING THE CENTRAL AREA TO BE FULLY CLEARED.**

## G. GREEN ON REQUEST MODE:



### Mode available on Smart Millenium – Traffic Regulation fitted with regulation radars.

Equipped with vehicle detection radars built into each light-head, Smart Millenium – Traffic Regulation traffic PTLs enable the optimised, dynamic and automatic regulation of vehicle flows.

On red when no vehicle is detected, the PTLs automatically change to green when an approaching vehicle is detected. This mode enables the dynamic adjustment of vehicle flows and keeps waiting time to a minimum.

When traffic flows are equivalent on the different roads, the system regulates traffic by dynamically optimising flows.

**REMOTE CONTROL INTERFACE**

<div style="border: 1px solid #ccc; background-color: #e0e0e0; padding: 5px; margin-bottom: 5px;"> <span style="float: left;">T</span> <span style="float: right;">EPP</span> <div style="clear: both; text-align: center;">                 ◁ ▷             </div> <p style="text-align: center; margin: 0;"><b>GREEN ON REQUEST MODE</b></p> <p style="text-align: center; margin: 0;"><b>OK</b></p> </div>	
<div style="border: 1px solid #ccc; background-color: #e0e0e0; padding: 5px; margin-bottom: 5px;"> <span style="float: left;">T</span> <span style="float: right;">EPP</span> <div style="clear: both; text-align: center;">                 ◁ ▷             </div> <p style="text-align: center; margin: 0;"><b>JUNCTION TYPE CROSSED</b></p> <p style="text-align: center; margin: 0;"><b>OK</b></p> </div>	Available choices: Crossed or Rotating
<div style="border: 1px solid #ccc; background-color: #e0e0e0; padding: 5px; margin-bottom: 5px;"> <span style="float: left;">T</span> <span style="float: right;">EPP</span> <div style="clear: both; text-align: center;">                 ◁ ▷             </div> <p style="text-align: center; margin: 0;"><b>NR. VEHIC / DAY LESS THAN 2,000</b></p> <p style="text-align: center; margin: 0;"><b>OK</b></p> </div>	Available choices: < 2,000 / 2 to 5,000 / 5 to 8,000 / 8 to 11,000 / 11 to 14,000
<div style="border: 1px solid #ccc; background-color: #e0e0e0; padding: 5px; margin-bottom: 5px;"> <span style="float: left;">T</span> <span style="float: right;">EPP</span> <div style="clear: both; text-align: center;">                 ◁ ▷             </div> <p style="text-align: center; margin: 0;"><b>SELECT DISTANCE 100m</b></p> <p style="text-align: center; margin: 0;"><b>OK</b></p> </div>	Available choices: 20 to 2,000 m <i>Pressing and holding the UP and DOWN keys allows the user to quickly increase or decrease the distance in increments.</i>
<div style="border: 1px solid #ccc; background-color: #e0e0e0; padding: 5px; margin-bottom: 5px;"> <span style="float: left;">T</span> <span style="float: right;">EPP</span> <div style="clear: both; text-align: center;">                 ◁ ▷             </div> <p style="text-align: center; margin: 0;"><b>PROGRAMME MODE FINISHED</b></p> </div>	



**GREEN ON REQUEST MODE ONLY AVAILABLE IF ALL PAIRED PTLs ARE EQUIPPED WITH REGULATION RADARS AND LOCATED AT A MAXIMUM DISTANCE OF 800 M.**



**CYCLES BEGIN AFTER ALL RED ALLOWING THE CENTRAL AREA TO BE FULLY CLEARED.**



## H. PLANT CROSSING FUNCTION:

The plant crossing function involves interrupting current cycles on lanes reserved for traffic to allow worksite vehicles to safely leave the area.

Plant crossing can be activated or deactivated in all modes once programming has been completed, except for MANUAL ALTERNATING mode.

There are 2 possible worksite configurations:

- Worksite road(s) equipped with a PTL (see chapter STANDARD + WORKSITE EXIT)
- Worksite road(s) without a PTL

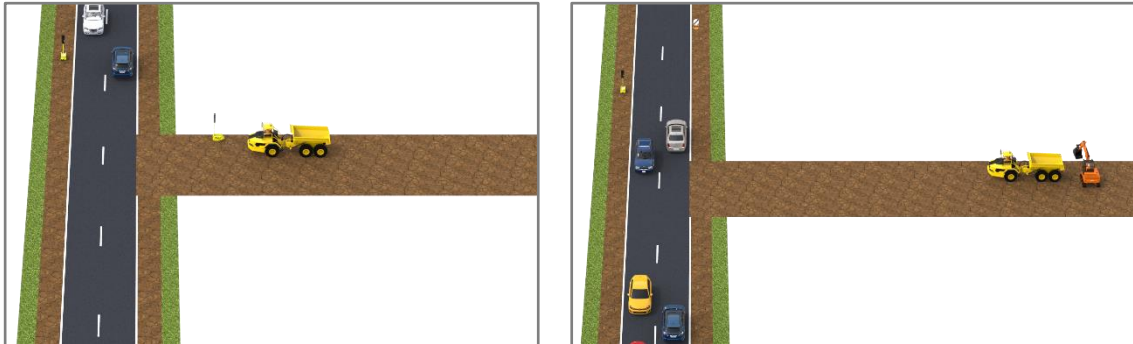

*For worksite road(s) equipped with a PTL, select STANDARD + WORKSITE EXIT mode.*

### Activate PLANT CROSSING:

MILLENIUM:

- manually by pressing the **STOP** button on the remote control for 5 seconds

SMART MILLENIUM – Traffic Regulation: 2 possible choices (to be defined at the programming stage)

- manually by pressing the **STOP** button on the remote control for 5 seconds
- automatically when a vehicle is detected approaching the WORKSITE traffic lights (maximum distance between PTLs : 800m)

*Choice of automatic activation is only available in STANDARD + WORKSITE EXIT mode.*

### Deactivate PLANT CROSSING:

MILLENIUM: 2 possible choices (to be defined at the programming stage)

- manually by pressing the **STOP** button on the remote control for 5 seconds
- automatically after ALL RED defined based on programming (not available if PTLs are synchronised. Maximum distance between PTLs : 800m)

SMART MILLENIUM – Traffic Regulation: 2 possible choices (to be defined at the programming stage)

- manually by pressing the **STOP** button on the remote control for 5 seconds
- automatically: Plant crossing is interrupted when there is no approaching vehicle detected for 8 seconds at the worksite exit PTL; Plant crossing duration is limited to 30 seconds (maximum distance between PTLs : 800m).

*Choice of automatic deactivation is only available in STANDARD + WORKSITE EXIT mode.*

## 8. CYCLE IN PROGRESS

Once programming has been completed, the current programming can be viewed from the remote control. Pressing one of the keys gives users access to CYCLE IN PROGRESS with details of the current programming.

## 9. PARAMETERS MENU

The PARAMETERS menu is used to configure the following functions:

### **A. LANGUAGE:**

Available languages: English/German/Spanish/Flemish/French/Italian/Polish/Portuguese/Czech

### **B. REMOTE CONTROL SETTINGS:**

STANDBY REMOTE CONTROL: to adjust the screen timeout time

SCREEN BACKLIGHTING: to adjust the screen brightness

PROGRAMMING DELAY FOR SCAN: to set the maximum duration permitted to scan the different PTLs in an infrared system

ADD REMOTE CONTROL: to add a remote control to a current system

### **C. PTL SETTINGS:**

The PTL SETTINGS menu makes it possible to deactivate the following features:

ACCELEROMETER: the accelerometer detects PTL that have fallen or moved. Alerts are automatically reported to the remote control 15 minutes after the end of a programming, enabling operators to deploy PTLs on the ground. 15 minutes after programming, if a PTL has fallen or moved, the PTLs switch to safety mode; a MOVED PTL alarm is reported to the remote control within 30 seconds. When a PTL is repositioned, the alarm is raised after 35 seconds, and the PTLs resume their cycle after All Red.

RADIO: to create a system of PTLs and communicate between the PTLs and the remote.

RADAR: to automatically regulate traffic (only available on Smart Millenium – Traffic Regulation).

INTERNAL COUNTDOWN TIMER: can be deactivated when an external countdown time is used; the internal countdown timer behaves like a classic orange light.

ADD PTL: to replace a damaged or faulty PTL or add a PTL to a paired system.

### **D. INFORMATION:**

BATTERY CHARGE: estimated real-time battery charge level of system's PTLs

HISTORY OF RECEIVED ALARMS: history of alerts or faults collated by the PTL system

PTL ID: to display the A, B, C, D ID of the PTL on the central lens

SERIAL NUMBER: to display the serial number of PTLs in a system

### **E. MAINTENANCE:**

OPTICAL TEST: used to activate the different lenses to check how they are working (function not available when PTLs are in operation)

### **F. RESET:**

SYSTEM: resets the remote control

PASSWORD: resets the password allowing access to SMART MILLENIUM features

## 10. SMART MILLENIUM MENU

Intended for those leasing, this menu is used to activate or deactivate SMART MILLENIUM functionality. Menu only accessible when all paired PTLs are SMART MILLENIUM.

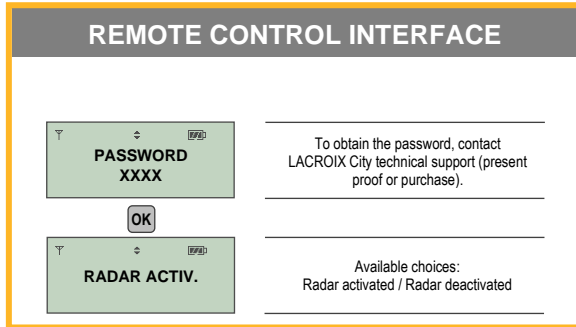

TO OBTAIN THE PASSWORD, CONTACT LACROIX CITY TECHNICAL SUPPORT (PRESENT PROOF OR PURCHASE).

## 11. PTL SHUTDOWN / STANDBY

### A. SHUTDOWN PTLs:

There are 2 ways to shut down the PTLs:

- 1) From the SYSTEM SHUTDOWN menu → SYSTEM SHUTDOWN
- 2) By disconnecting the battery on each PTL (see procedure in the BATTERY section below)

Note: when the batteries are disconnected without going through the SYSTEM SHUTDOWN menu, the PTL pairing is retained.

Note: the SYSTEM SHUTDOWN menu is equivalent to the end of a worksite and thus when shutting down paired PTLs, the pairing is removed and will have to be performed again if the same system is redeployed.

Note: as a connected battery will discharge (even one that is not used), ensure that the battery cables are disconnected after use.

### B. PLACE PTLs ON STANDBY:

Placing the PTLs on standby allows the lenses to be switched off whilst retaining the current programming in the background. When standby mode is deactivated, the lenses come back on and the PTLs resume their cycle.

Placing the PTLs on standby from the SYSTEM SHUTDOWN menu → PTL STANDBY

## 12. REMOTE CONTROL



### A. ACTIVATION

The remote control can be activated by quickly pressing on any key.

### B. STANDBY:

To optimise the remote control's battery life, the device is configured by default to enter standby mode after 1 minute. In order to preserve the remote control's battery life, it is recommended to select the shortest time to enter standby mode. The time to enter standby mode can be configured from the remote control's PARAMETERS menu. In standby mode, the remote control continues to communicate with the current traffic light system in order to collate alert messages and inform the user.

### C. REMOTE CONTROL SCREEN:

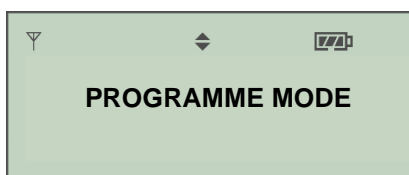

Symbol displayed when PTLs are paired on the remote control  
Flashing symbol in case of a radio error



Symbol informing that an up/down choice is possible



Remote control charge

### D. SWITCH OFF REMOTE CONTROL:

To ensure a continuous connection with the current PTL system, the remote control cannot be switched off; once the PTL system has shut down, the remote control enters extended standby mode and stops communicating in order to conserve its battery.

### E. AUDIBLE ALARMS:

The remote control is fitted with an audible alarm to inform the user about an alert or a fault with the PTL system. After sounding for 5 seconds, the alarm stops automatically. Configured by default, the audible alarm can be deactivated from the remote control's PARAMETERS menu.

**F. POWER SUPPLY:**

The remote control is powered by 3 LR03 AAA batteries that can be accessed from the battery panel that is attached by 2 cross-head screws.

The pairing and programming for the PTLs are retained while the batteries are replaced. The alert history is deleted.



**G. ADDING A REMOTE CONTROL TO A PTL SYSTEM:**

Up to 3 remote controls can be paired to a PTL system. Adding an additional remote control is available from the PARAMETERS → MENU REMOTE CONTROL SETTINGS → ADD REMOTE CONTROL

**H. SYSTEM RESET:**

A system reset deletes the current pairing and alert history.

The system reset can be accessed from the PARAMETERS → RESET SYSTEM



PERFORMING A RESET DURING A CURRENT CYCLE WILL CAUSE THE PTL TO SHUT DOWN.

**13. RADIO**

**RADIO RANGE:**

The radio range of the PTLs and remote control is 800 m in the open. If there is disturbance, alerts are reported to the remote control.

**LOSS OF RADIO SIGNAL:**

For losses of radio signal lasting 15 secs or more, an alarm is reported to the remote control. In order to maintain the current cycle and ensure normal operation, the PTLs change based on time if STANDARD or MANUAL modes are in operation. If STANDARD + WORKSITE EXIT, AUTOMATIC REGULATION, GREEN ON REQUEST modes are in operation, the PTLs switch to safety mode. If MANUAL ALTERNATING mode is active, the current status is preserved. If the radio link is re-established, the PTLs return to their initial mode 5 minutes after the connection is re-established in order to ensure the stability of the connection.

**RADIO DEACTIVATION:**

If there is interference on a worksite due to a building or any other feature, it is possible to deactivate the radios from the PARAMETERS menu → PTL SETTINGS → RADIO. Once the radios have been deactivated, the programming and PTL monitoring must then be performed using short-range infrared from behind each light-head, alerts are no longer reported to the remote control.

## 14. RADAR

Smart Millenium PTLs are fitted with radars built into each light-head. In the event of a radar fault, an alert is reported to the remote control. In the event of a radar fault when a mode requiring the use of radars is selected and in operation, the PTLs automatically switch to STANDARD mode, and an alert is then reported to the remote control.

VEHICULE ACTUATED and GREEN ON REQUEST modes are only available if all paired PTLs are fitted with radars.



IT IS POSSIBLE TO ADD RADARS TO PTLs NOT EQUIPPED WITH THEM.  
CONTACT LACROIX CITY FOR MORE INFORMATION.

## 15. AVAILABLE OPTIONS

### A. FLASHING BEACON:

The flashing beacon provides information about the status of the red lens by lighting up from the back of the light-head when the red lens is lit. Hence, the flashing beacon helps people working on the site to better analyse vehicle movements and increase safety in the worksite area. The flashing beacon option is especially recommended when using MANUAL ALTERNATING mode.



### B. ANTI-THEFT BAR:

The anti-theft bar secures the battery by preventing the battery cover from being opened. It is inserted into the space provided in the chassis and crosses over the cover, securing both components. The slot provided in the chassis allows the padlock (not supplied) to be positioned in such a way as to make it hard to access by theft devices.



### **C. EXTERNAL COUNTDOWN TIMER:**

The external countdown timer displays the remaining time in seconds.

### **D. ANTI-THEFT CAGE:**

The anti-theft cage developed by LACROIX City offers an optimal anti-theft solution by preventing PTLs from being moved.

## 16. BATTERY

A connected battery, even one that is not used, will discharge by itself. For equipment not used for a long period of time, ensure the battery's cables are disconnected and charge before use.

### **REPLACING THE BATTERY:**

When changing a battery, the programming is saved for 20 minutes, allowing the user to replace a battery without losing the current programming.

### **VIEWING CHARGE STATUS:**

Once the PTLs have been paired, the battery charge level can be viewed from the remote control:  
PARAMETERS MENU → BATTERY CHARGE → INFORMATION

*Battery level for information purposes as can vary according to the air temperature, the type of battery used, the selected mode and the conditions of use.*

**TYPES OF BATTERIES SUPPORTED:** LEAD / **MAXIMUM CAPACITY SUPPORTED:** 220 Ah

**LIGHT VOLTAGE:** NOMINAL: 12 V / MINIMUM: 10.2 V / MAXIMUM: 14.2 V

### **INSTALLATION:**

Clean the battery terminals and connection lugs thoroughly. Start by connecting the positive terminal (+ / red) then the negative terminal (- / black). Only an authorised person is permitted to install the battery. Please follow the battery manufacturer's instructions.

### **REMOVAL:**

After each use, disconnect the battery to conserve its charge. Start by disconnecting the negative terminal (- / black) then the positive terminal (+ / red). Only an authorised person is permitted to remove the battery. Please follow the battery manufacturer's instructions.

### **CHARGE:**

Please follow the battery manufacturer's charging instructions.

### **RECYCLING:**

Please follow the battery manufacturer's recycling instructions.

### **WARNING:**

Disposing of a battery in a fire or a hot oven, or mechanical crushing or cutting is likely to cause an explosion.

Maintaining a battery in a very-high-temperature environment can cause an explosion or the leakage of flammable liquids or gases. Batteries exposed to extremely low air pressure can cause an explosion or the leakage of flammable liquids or gases.



**NOT OBSERVING THE AFOREMENTIONED SAFETY AND USAGE INSTRUCTIONS CAN LEAD TO AN EXPLOSION, ELECTRICAL SHOCK, FIRE, AND OR PERSONAL INJURY.**

## 17. TRANSPORTATION

The strap pass-throughs on the chassis help secure the PTLs during transportation; please prevent any impact that might damage the PTLs. Refer to the OVERVIEW paragraph in this manual.

## 18. CLEANING AND MAINTENANCE

Before cleaning the PTLs, ensure the batteries are disconnected. Never clean your equipment with a cleaning product or a solvent. Use a damp cloth and a mild detergent to clean the various surfaces of the equipment.

## 19. STANDARDS / SAFETY

### COMPLIANCE:



LACROIX City declares that this equipment complies with the EC Directive.

### RECYCLING:



The presence of the WEEE symbol means that this product and/or its battery must be disposed of separately from household waste in Europe and Turkey. The separate collection and recycling of the product and/or its battery help to preserve natural resources and ensure that it is recycled in a way that protects human health and the environment. This product must be taken to a collection point designated by local authorities when it has to be disposed of.

### WARNING:

This equipment is not suitable for use in premises where children may be present.

## 20. CONTACT TECHNICAL SUPPORT

For any questions, please contact LACROIX City Technical Support:

**TEL.:** +33 (0) 240 925 875

**EMAIL:** [contact.sav@lacroix-city.com](mailto:contact.sav@lacroix-city.com)

LACROIX City reserves the right to change its instruction manual without notice.